



# PROJECT: DISPLAY TUSSENPRESENTATIE

Door Coen Janssens

# INHOUD

- Conclusie onderzoek
- De drie concepten
- Spuugmodel
- Werktekening
- Prototype





# CONCLUSIE ONDERZOEK

Mijn onderzoek concludeerde dat min display aan 10 productvoorwaarde moest voldoen en dat is uiteindelijk gelukt.



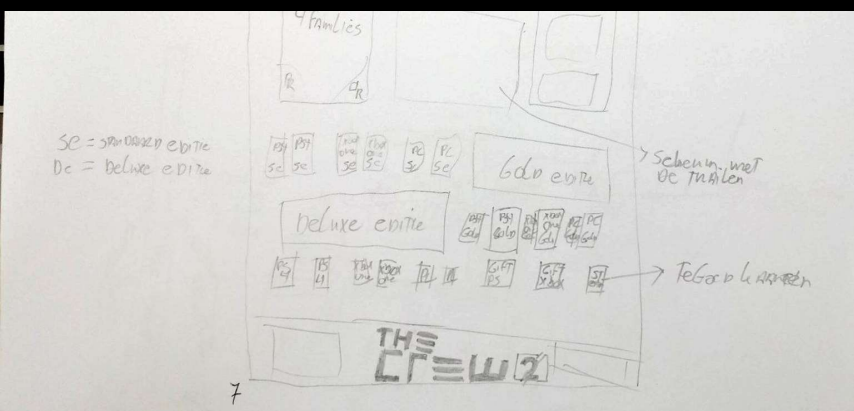
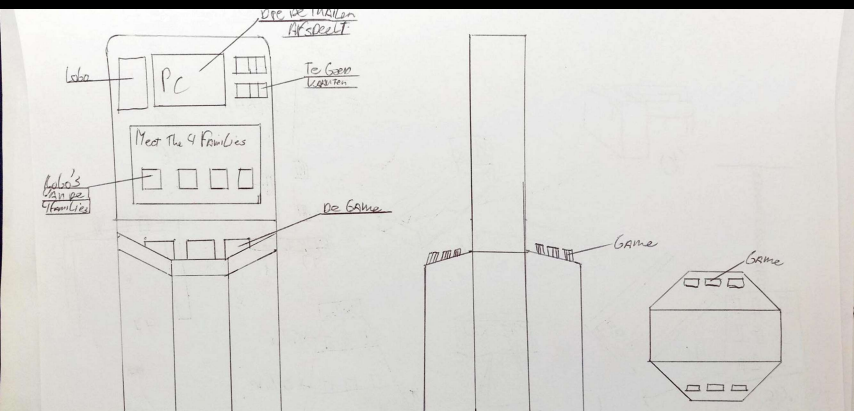
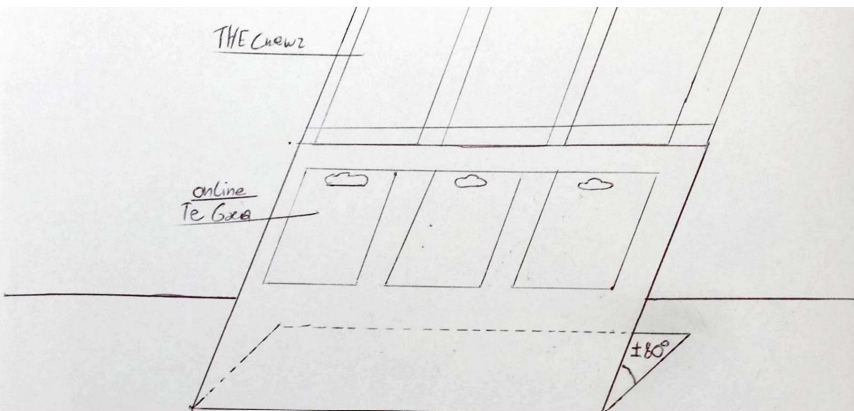

# DE DRIE CONCEPTEN

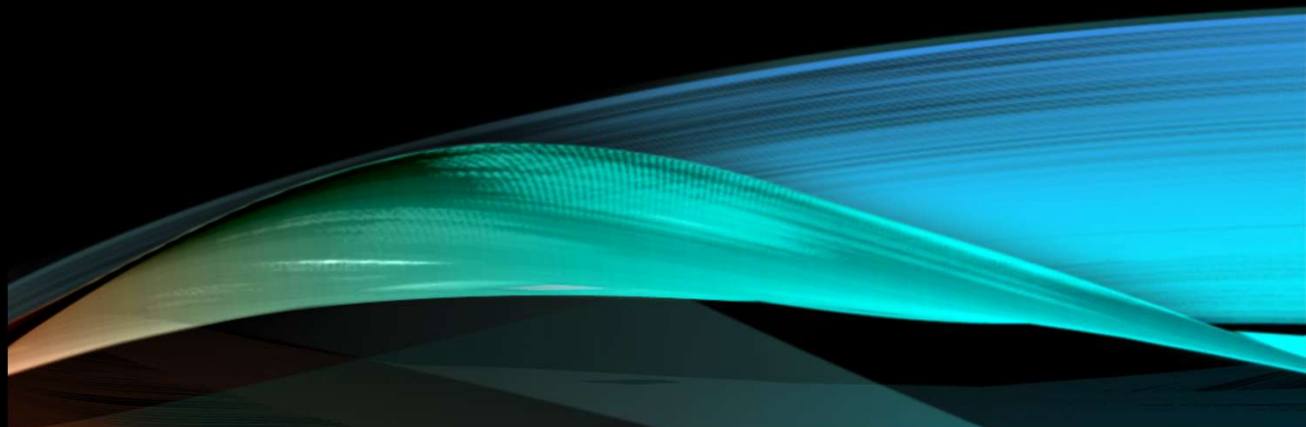



# SPUUGMODEL

geleerd:  
Toch precies  
Games goed positioneren



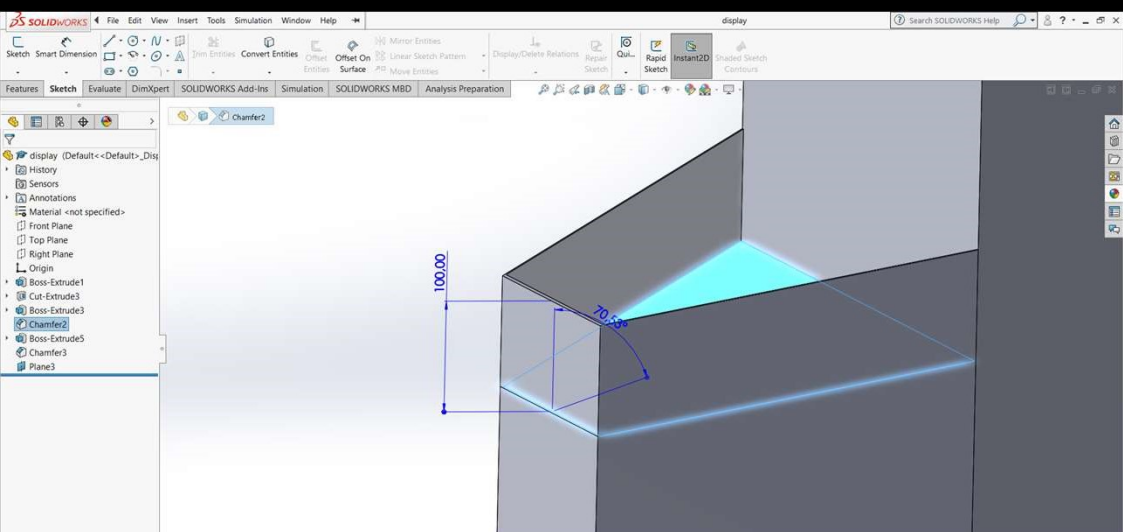
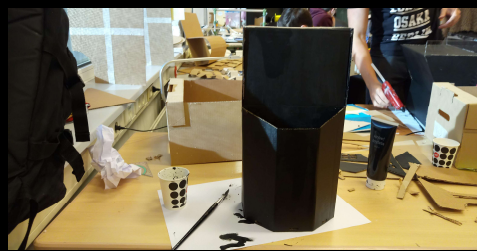
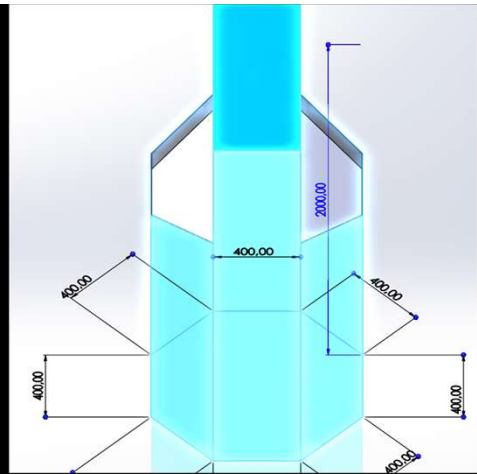
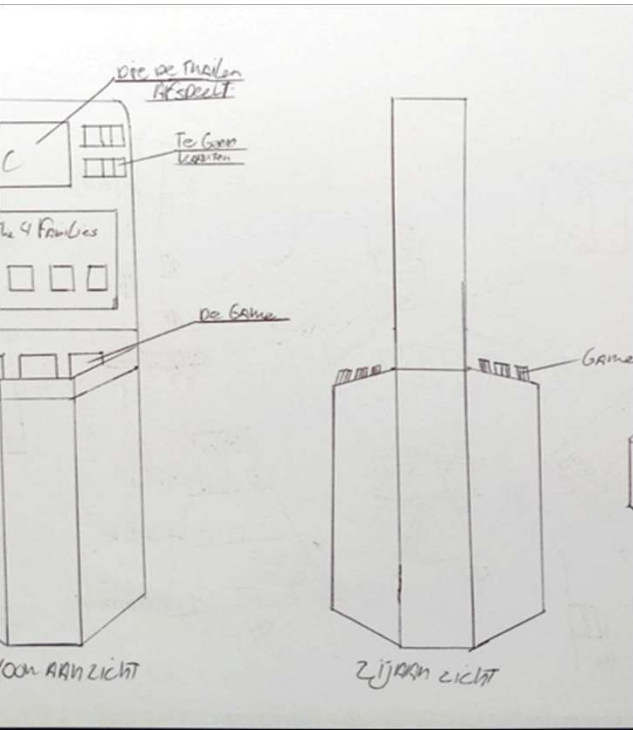

# WERKTEKENING

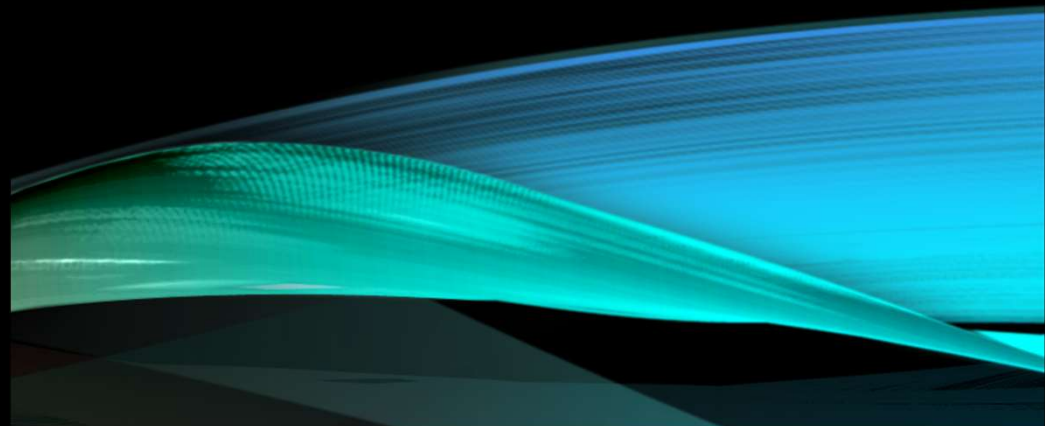

# PROTOTYPE



Belangrijke punten:

- Games staan getrapt
- In elkaar klikbaar, prototype niet gelukt
- 2 kanten



Wijzigingen:

- Extra bodem